

Anywire AnyWire System Product Guide

AnyWire Address Writer

ARW-04

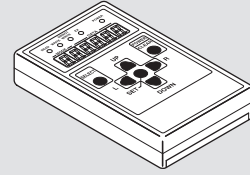

Infrared non-contact type

Remote head wearable

■ When using for the first time

Confirm the contents (P6 to 8) in the [Internal Setting].

[Notes on Safety]

Precautions that must be observed in order to use this system safely are indicated as shown below.

You must observe these precautions.



WARNING

A WARNING indicates a potentially hazardous situation which, if not handled correctly, could result in death or serious injury.



A CAUTION indicates a potentially hazardous situation which, if not handled correctly, may result in personal injury or property damage.



WARNING

○ System Safety

This system is intended for general industrial applications. It does not have functions for supporting applications requiring higher levels of safety such as safety-related devices or accident prevention systems. The product must not be used for these purposes.

○ Always turn off the power before installing or replacing the system.

○ For change of setting in the direct mode, values are updated to the changed values when they are written. Please note that direct changes of addresses and others may result in unexpected operation.



CAUTION

○ System power supply

Use a stable, 24V DC power supply. Use of an unstable power supply may cause problems with the system.

○ Separately route high-voltage and power cables

Although the AnyWire system has a high noise margin, keep the transmission line and I/O cables away from high-voltage and power cables.

○ Connectors and terminals

- Pay careful attention to the length and installation of cable wiring to ensure that connectors and cables are neither overloaded nor disconnected.

- Make sure to prevent any metal objects from getting inside the connectors or the terminal blocks.

- Short-circuits caused by metal objects or mis-wiring are likely to damage the device.

○ Do not impose any external loads on the units. Doing so may cause a failure.

○ Do not disconnect or reconnect between the transmission line and remote units when the transmission line is active. A malfunction may occur.

○ Use the AnyWire system within the range of the specifications and conditions shown below.

[Features]

- This is a unit of the AnyWire system. It is used for setting address numbers and operating specifications of units with a setting port. This writer enables address numbers and parameters to be set by the non-contact method.
- Reading and writing can be performed.
- As the body is small-sized and driven by battery, it has no power code and can be taken anywhere.
- As address numbers are displayed at a 7-segment display unit and can be used directly at the decimal scale, this eliminates inconveniences that it is hard to see the switch in a dark place and the set value must be calculated.
- A remote head (ARW-RH) to make writing in a narrow space or small-sized unit easier is prepared (separately sold).
- The writer has an automatic shutout function to protect the battery even when the power is left on. (The condition in the middle of the setting operation returns to the content before setting.)

[Included in the Package]

ARW-04 ... 1

AAA alkaline dry cell battery ... 2

[Warranty]

■ Warranty period

The warranty on the delivered Product shall continue to be effective for one (1) year after the delivery thereof to a location as designated by the original owner.

■ Scope of warranty

Should a defect occur in any part of the Product during the foregoing warranty period when it is used normally in accordance with the specifications described in this Product Guide, the Company shall replace or repair the defect free of charge, except when it arises as a result of:

- (1) Misuse or abuse of the Product by the owner;
- (2) Fault caused by other than the delivered Product;
- (3) The unauthorized modification or repair of the Product by any person other than the Company's personnel;
- (4) Any unusual force of nature, disaster or other cause beyond the Company's control.

The term "warranty," as used herein, refers to the warranty applicable to the delivered product alone. The Company shall not be liable for consequential or incidental damages resulting from any malfunction.

■ Repair at cost

After the expiration of the warranty period, the owner shall be responsible for all costs and expenses incurred for the troubleshooting and repair of the Product. Even during the warranty term, the Company shall repair any defects arising from causes other than within the scope of the warranty as specified above, at the owner's cost.

■ Changes in the product specifications and the descriptions in the manual

The descriptions in this manual may be subject to change without notice.

[Overview]

ARW-04 can read address numbers written in a terminal or write address numbers to a terminal using infrared ray. As the infrared ray emitting and receiving part is less influenced by ambient light, the writer can be used almost anywhere indoors. And the writer is capable of transmission and reception by pointing the light emitting and receiving part at the setting port of the unit and operating it because of the diffusion-type light emitting and receiving system.

■ Image of address reading

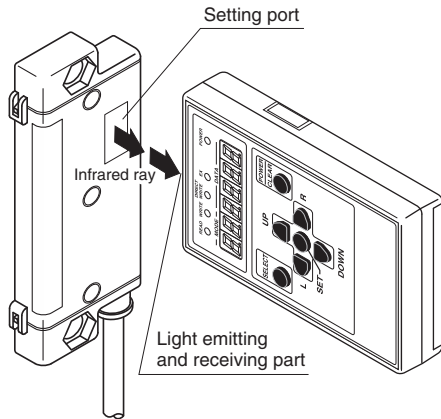

■ Image of operation

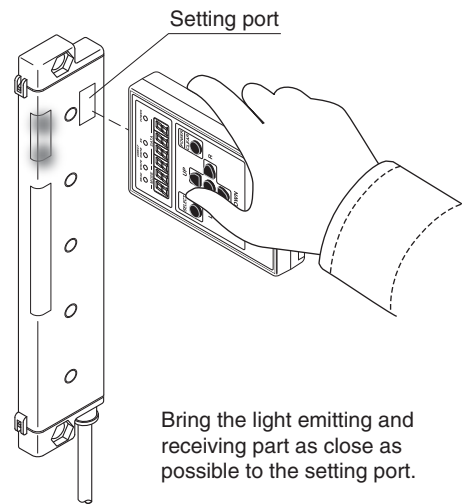

■ Image of address writing

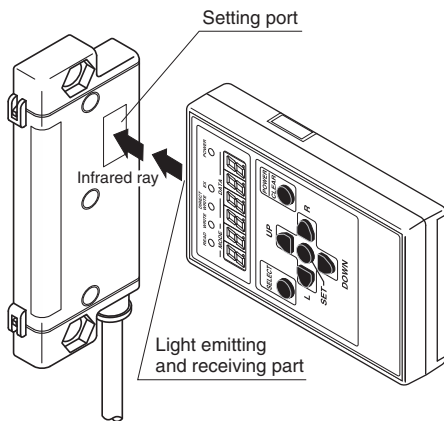

CAUTION When the light emitting and receiving part of ARW-04 and the setting port of a unit to be set are in strong ambient light such as direct sunlight, it may be impossible to write and read addresses. In such cases, please shade the light by your hands, etc.

■ Image with a remote head connected

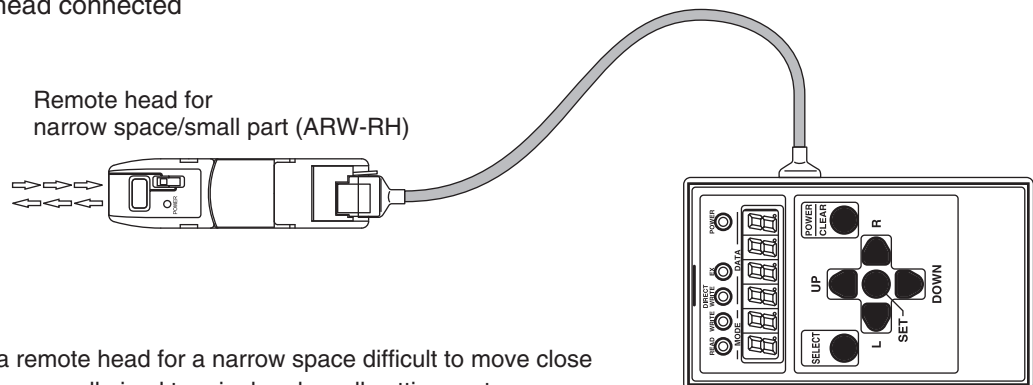

It is convenient to connect a remote head for a narrow space difficult to move close to the body of ARW-04 or for a small-sized terminal and small setting port.

For ARW-RH, refer to ARW-RH instruction manual.

[Operation Range]

Bring the light emitting and receiving part as close as possible to the setting port of the target unit to operate.
The guideline for the light emitting and receiving range is as follows:

■ Guideline for positions in reading and writing address numbers

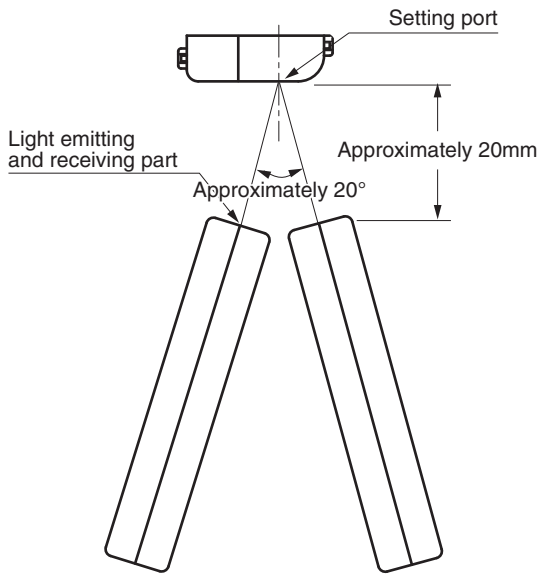

[Seen from the top]

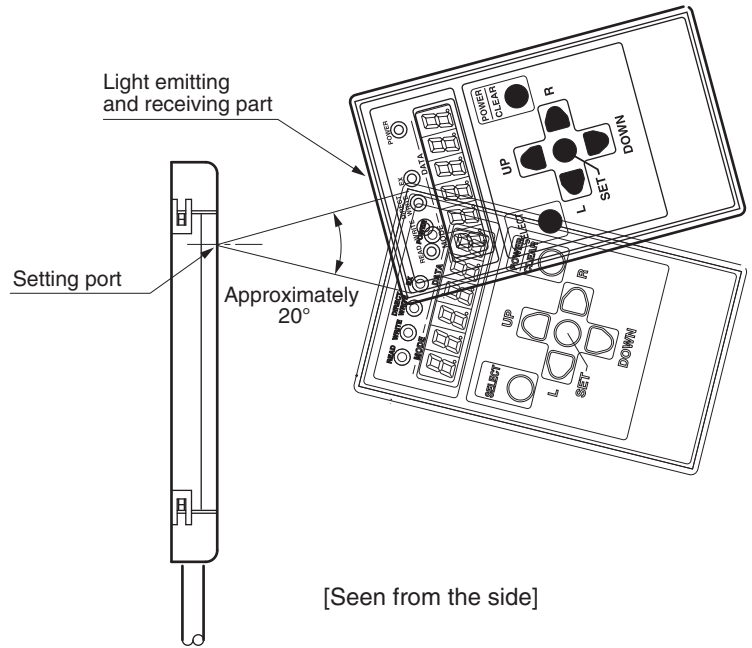

[Seen from the side]

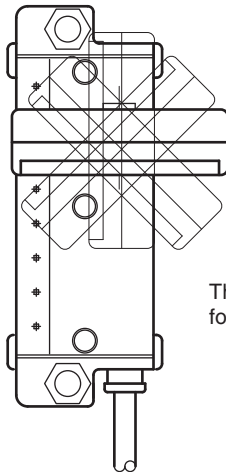

[Front]

The vertical directions are not specified for the front of ARW-04.

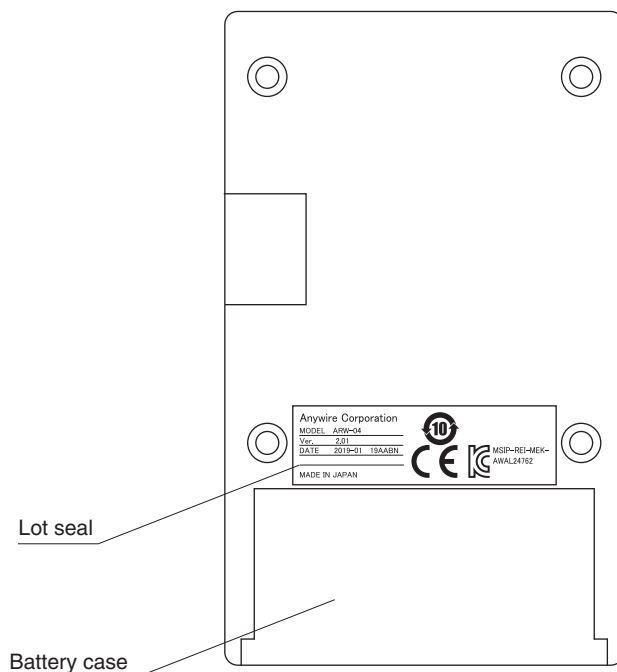
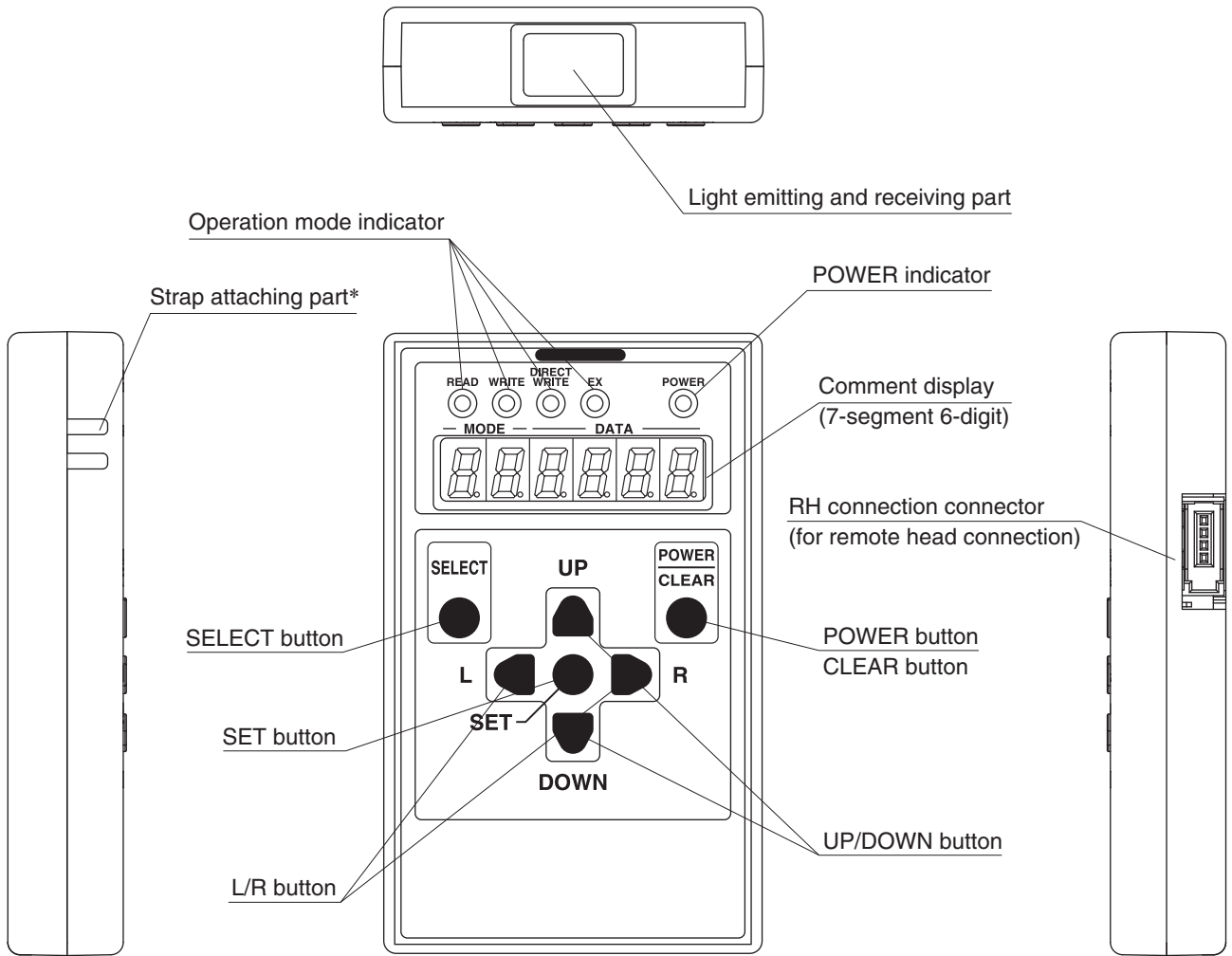

*DATE 2020-09-20IBBNA or former models are not equipped with the strap attaching part. A ring for strap is attached to these models.

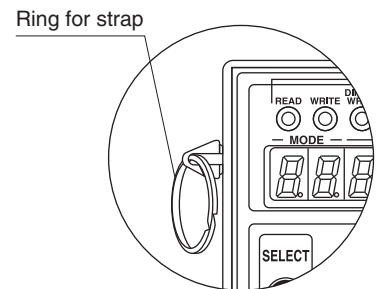

[Operation Mode]

The following operations are available for the ARW-04.

Item	Function explanation	Set value renewal timing	Mode to be selected	Explanation page
Internal setting	Perform the internal setting of the address writer.	When the power is reset	Maximum points setting mode (Factory setting: 512)	6, 7, 8
			Maximum number of parameters setting mode (Factory setting: 18*)	
			Decimal/hexadecimal display setting mode (Factory setting: Decimal)	
			Automatic carry of parameter set value YES/NO setting mode (Factory setting: NO)	
			Address writer mode (Factory setting: ARW-04)	
Teaching	Adjust ASLINKSENSOR or ASLINKAMP.	Immediately after operation	EX mode	9
Reading	Read an address number or parameter.	—	READ mode	10, 11
Writing	Write an address number or parameter.	When the power is reset	WRITE mode	13, 15
Direct writing	Write an address number or parameter.	Immediately after operation	DIRECT WRITE mode	14

*The factory setting is 0 when DATE of the lot seal is 2017-4 17D or before.

When using an address writer for the first time, confirm the next section, "Internal Setting," and after completing the internal setting, perform various setting operations.



Since the maximum number of parameters of factory setting DATE2017-5 17E or after is "18," the reading or writing of parameters is already possible in the status of factory setting, but confirm with the product manual of each product and perform the setting of the maximum number of parameters to prevent the writing of unnecessary parameters.

Since the maximum number of parameters of factory setting DATE2017-4 17D or before is "0," setting is required to read and write parameters.

Also, regarding the maximum points setting, although it can be used in the factory setting (512 points), match the internal setting of the address writer with the writing target device to prevent the writing of wrong address numbers. (Ex.: In case of AnyWireASLINK, maximum points setting is 256 points.)

[Internal Setting]

Before using the address writer, confirm the series or number of parameters of set target products and match the internal setting of the address writer with them.

■ Contents to be checked

The contents to be checked are the “maximum points setting mode,” “maximum number of parameters setting mode,” “decimal/hexadecimal display setting mode,” “automatic carry of parameter set value YES/NO setting mode,” and “address writer mode.”

Factory setting	Setting item	Set value	Content of set value
Ad512	Maximum points setting mode (Factory setting: 512)	Ad256	The upper limit address number is 255
		Ad512	The upper limit address number is 511
Pa18	Maximum number of parameters setting mode (Factory setting: 18*)	Pa00 ~ Pa09	The number of parameters available in the parameter mode (Ex.) Pa04 If the parameter is set to 04, 4 types (01 to 04) can be selected in parameter mode.
DdDEC	Decimal/hexadecimal display setting mode (Factory setting: Decimal)	DdDEC	Decimal display
		DdHEX	Hexadecimal display
PpYES	Automatic carry of parameter set value YES/NO setting mode (Factory setting: NO)	PpYES	When the parameter set value is changed, carry is automatically performed
		PpNO	When the parameter set value is changed, carry is not automatically performed
AdARW	Address writer mode (Factory setting: ARW-04)	AdARW	ARW-04
		AdARW	ARW-03 (This is a former address writer mode. Four-digit numbers are not available. It works in decimal, automatic carry YES mode.)

* The factory setting is 0 when DATE of the lot seal is 2017-4 17D or before.

● Maximum points setting mode

Perform setting depending on the AnyWire series to be used to prevent the writing of wrong address numbers.

	Maximum points setting	
	256 points	512 points
Address number available for setting	0-255	0-511



Although address setting for all series is available in the factory setting (512 points), unexpected operation may be caused by the writing of address numbers of 256 or more in the case of AnyWireASLIK, Bitty series. Use the writing target system and internal setting together to prevent the writing of wrong address numbers. Maximum control points of AnyWireASLINK, Bitty series: Input 256 points/output 256 points (AnyWire DB A20 series: Input 512 points/output 512 points)

● Maximum number of parameters setting mode







The number of parameters available for setting depends on products. Set it according to products to prevent a malfunction caused by the writing of unnecessary parameters.



Since the maximum number of parameters of factory setting DATE2017-5 17E or after is “18,” the reading or writing of parameters is already possible in factory setting, but confirm with the product manual of each product and perform the setting of the maximum number of parameters to prevent the writing of unnecessary parameters. Since the maximum number of parameters of factory setting DATE2017-4 17D or before is “0,” reading or writing parameters is not available until the internal setting is completed.

■ Setting operation

	How to operate	Display	Description	Set sound	
Maximum points setting mode	1	Turn ON the POWER button pressing SELECT button	Ad [^] 256 or Ad [^] 512	Current maximum points setting mode	Beep, beep, beep
	2	Press the SET button	Ad [^] 256 [^] or Ad [^] 512 [^]	Flashing dots move to the right	Beep
	3	Display the number to be set by the UP/DOWN button and press the SET button (Pressing the R button displays Ad [^] 256 [^])	8885EE	After "SET" is displayed, the set value is displayed again	Beep BEEP!
			Ad [^] 256 [^] Ex.)	When 256 points are set as the maximum points	
4	Press the L button or the CLEAR button	Ad [^] 256 or Ad [^] 512	Flashing dots move to the left	Beep	
Maximum number of parameters setting mode	5	Press the UP button once to set the number of parameters to set	P [^] 0000 ~ P [^] 0009	Current maximum number of parameters selected	
	6	Press the SET button	P [^] 0000 [^] ~ P [^] 0009 [^]	Flashing dots move to the right	Beep
	7	Display the number to be set by the UP/DOWN button and press the SET button (Pressing the R button displays P [^] 0000 [^])	8885EE	After "SET" is displayed, the set value is displayed again	Beep BEEP!
			P [^] 0000 [^] Ex.)	When 10 is set as the number of parameters	
8	Press the L button or the CLEAR button	P [^] 0000 ~ P [^] 0009	Flashing dots move to the left	Beep	
Display setting mode	9	Press the UP button once to set the 7-segment display method	8888E0 or 8888EH	Current 7-segment display method	
	10	Press the SET button	8888E0 [^] or 8888EH [^]	Flashing dots move to the right	Beep
	11	Display the number to be set by the UP/DOWN button and press the SET button (Pressing the R button displays 8888E0 [^])	8885EE	After "SET" is displayed, the set value is displayed again	Beep BEEP!
			8888EH [^] Ex.)	When set to hexadecimal display	
12	Press the L button or the CLEAR button	8888E0 or 8888EH	Flashing dots move to the left	Beep	
Automatic carry of parameter set value YES/NO setting mode	13	Press the UP button once to set YES or NO for the automatic carry of parameter set value	P [^] 04E5 or P [^] 0000	Current parameter automatic carry YES/NO	
	14	Press the SET button	P [^] 04E5 [^] or P [^] 0000 [^]	Flashing dots move to the right	Beep
	15	Display the number to be set by the UP/DOWN button and press the SET button (Pressing the R button displays P [^] 0000 [^])	8885EE	After "SET" is displayed, the set value is displayed again	Beep BEEP!
			P [^] 0000 [^] Ex.)	In case of setting the automatic carry to NO	
16	Press the L button or the CLEAR button	P [^] 04E5 or P [^] 0000	Flashing dots move to the left	Beep	

		How to operate	Display	Description	Set sound
Address writer mode	17	Press the UP button once to set the address writer mode	 or 	Current address writer mode	
	18	Press the SET button	 or 	Flashing dots move to the right	Beep
	19	Display the number to be set by the UP/DOWN button and press the SET button (Pressing the R button displays )		After "SE" is displayed, the set value is displayed again	Beep BEEP!
			 Ex.)	When ARW-04 mode is set	
20	Hold down the POWER button to turn OFF the power				

[Teaching...EX Mode]

This is the mode to perform teaching [operation to store the status of the presence/absence of work before use in memory], which is necessary when using ASLINKAMP and ASLINKSENSOR.



The necessity of teaching setting depends on products. Refer to the product manual of each product for details.

■ Setting operation

	How to operate	Display	Description	Set sound
1	Hold down the POWER button	048001	After the version is displayed	Beep, beep
		SELECT	SELECT flashes	
2	Press the SELECT button	-----	----- Flashing	Beep
3	Press the SELECT button to turn on the EX indicator (red)	EX (red)	The SEt on mode is selected	Beep
4	Press the SET button	SEt000	The SEt on mode is determined	Beep
5	After the state where the corresponding terminal detects a work, point the light emitting and receiving part at the setting port, and press the SET button	SE0000	During the setting operation	Beep
6	When SEton setting is correctly set, "Good" is displayed and then "SEton" is displayed again.	Good	Correctly completed	BEEP!
		SEt000	Setting is completed	
7	If SEton setting is not correctly set, "SE Err" is displayed. Reset the light emitting and receiving part, and press the SET button again until Operation No.6 is completed	SEERR	Err display	Beep, beep, beep, beep, beep
8	After SEton setting is completed, press the UP or DOWN button once	SEt0FF	SEt OFF mode	
9	In the state where there is no work in the corresponding terminal, point the light emitting and receiving part at the setting port, and press the SET button	SE0000	During the setting operation	Beep
10	When SEtoFF setting is correctly set, "Good" is displayed and then "SEtoFF" is displayed again	Good	Correctly completed	BEEP!
		SEt0FF	Setting is completed	
11	If SEton setting is not correctly set, "SE Err" is displayed. Reset the light emitting and receiving part, and press the SET button again until Operation No.10 is completed	SEERR	Err display	
12	- Clear the Err display - Change to another mode Press the CLEAR button			
13	When moving to the next setting, press the SELECT button	READ (green) WRITE (yellow) DIRECT WRITE (orange) EX (red)		

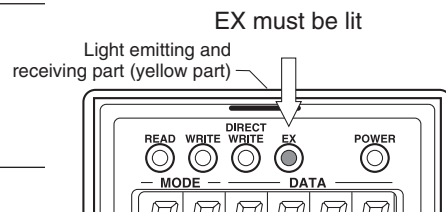

[Reading...READ Mode]

This is the mode to read addresses and parameters that have been set in a remote unit.
Make sure that power and transmission signal are normally supplied to the relevant remote unit.

■ Address reading operation

	How to operate	Display	Description	Set sound
1	Hold down the POWER button	048000	After the version is displayed	Beep, beep
		SELECT	SELEct flashes	
2	Press the SELECT button	888888	----- Flashing	Beep
3	Press the SELECT button to turn on the READ indicator (green)	READ (green)	The READ mode is selected	Beep
4	Press the SET button	Ad8888	The READ mode is determined	Beep
5	Point the light emitting and receiving part at the setting port of the target unit, and press the SET button	Ad8888	During the reading operation	Beep
		Ad8888 Ex.)	The address number is displayed When the read address number is bit address 16	BEEP!
6	In the case of success in reading H indicates word address.	AdH888 Ex.)	The address number is displayed When the read address number is word address 7	
		Address reading operation (Operation No. 5) for a different unit can be performed		
7				
8	In the case of failure in reading	Ad8888	Err display	Beep, beep, beep, beep, beep
9	Reset the light emitting and receiving part, and press the SET button again to repeat the reading operation (Operation No. 5)			
10	- Clear the Err display - Change to another mode Press the CLEAR button	Ad8888	Return to READ mode display	
11	When moving to the next setting, press the SELECT button to light up the display of the desired mode	READ (green) WRITE (yellow) DIRECT WRITE (orange) EX (red)		Beep

CAUTION

To read a word address from a word-compatible remote unit, an address writer of Ver. 2.01 or later version is required.
If you attempt to read a word address from a word-compatible remote unit by using an address writer of a version before Ver. 1.02, "Ad. 999" is displayed.

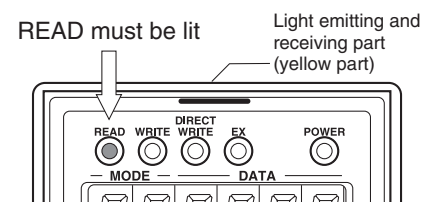

■ Parameter reading operation

	How to operate	Display	Description	Set sound
1	Hold down the POWER button	04:0001	After the version is displayed	Beep, beep
		SELECT	SELECT flashes	
2	Press the SELECT button	□□□□□□	Flashing	Beep
3	Press the SELECT button to turn on the READ indicator (green)	READ (green)	The READ mode is selected	Beep
4	Press the SET button	Ad.□□□□	The READ mode is determined	Beep
5	Select the parameter to be read by using the UP/DOWN button	0□.□□□□ Ex.)	When selecting parameter 1	
6	Point the light emitting and receiving part at the unit, and press the SET button	010989	Reading	Beep
7	In the case of success in reading	0□.□□50 Ex.)	Example of a read parameter	BEEP!
8	Parameter reading operation (Operation Nos. 5 and 6) for a different unit can be performed			
9	In the case of failure in reading	01.8ERR	Err display	Beep, beep, beep, beep
10	Reset the light emitting and receiving part, and press the SET button again to repeat the reading operation (Operation No. 6)			
11	- Clear the Err display - Change to another mode Press the CLEAR button	01.□□□□ Ex.)	Return to READ mode display	
12	When moving to the next setting, press the SELECT button to light up the display of the desired mode	READ (green) WRITE (yellow) DIRECT WRITE (orange) EX (red)		Beep

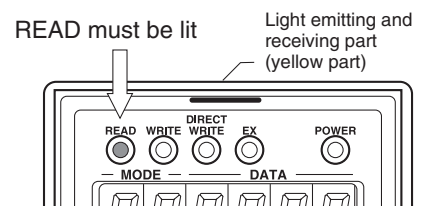

[Writing...WRITE/DIRECT WRITE Mode]

This is the mode to write addresses and parameters that have been set in a remote unit.
Make sure that power and transmission signal are normally supplied to the relevant remote unit.

Mode	Details
WRITE	When the power of the terminal and transmission signals are turned off after the writing operation and turned on again, the written values become available.
DIRECT WRITE	The written values become available at the time when addresses are written. * As addresses can be updated with the power on, this is an easy method. However, it requires careful attention to operation so that unexpected terminal movement may not cause an accident.

■ Address number writing operation

Writing "bit address" in the WRITE mode (example)

	How to operate	Display	Description	Set sound
1	Hold down the POWER button	043101	After the version is displayed	Beep, beep
		SELECE	SELECE flashes	
2	Press the SELECT button	888888	Flashing	Beep
3	Press the SELECT button to turn on the WRITE indicator (yellow)	WRITE (yellow)	The WRITE mode is selected	Beep
4	Press the SET button	Ad.8888	The WRITE mode is determined	Beep
5	Press the SET button	Ad.8888	Flashing dots move to the right	Beep
6	Display the address number to be written by using the UP/DOWN button If the set value is 0, each time the R button is pressed, +50 is added. If the number exceeds 255 or 511 (initial setting), it returns to 0. If the set value is not 0, it returns to 0 when the R button is pressed.	Ad.8888 Ex.)	When setting to bit address 4	
7	Point the light emitting and receiving part at the setting port of the target unit, and press the SET button	Ad.8888	During the writing operation	Beep
8	In the case of success in writing	GGood	After Good flashes	BEEP!
		Ad.8888 Ex.)	The written value is displayed	
9	Address writing operation (Operation Nos. 6 and 7) for a different unit can be performed			
10	In the case of failure in writing	Ad.8888	Err display	Beep, beep, beep, beep, beep
11	Reset the light emitting and receiving part, and press the SET button again to repeat the writing operation (Operation No. 7)			
12	- Clear the Err display - Change to another mode Press the CLEAR button	Ad.8888 Ex.)	Return to WRITE mode display	Beep
13	Press the CLEAR button	Ad.8888 Ex.)	Flashing dots move to the left	Beep
14	When moving to the next setting, press the SELECT button to light up the display of the desired mode	READ (green) WRITE (yellow) DIRECT WRITE (orange) EX (red)		Beep

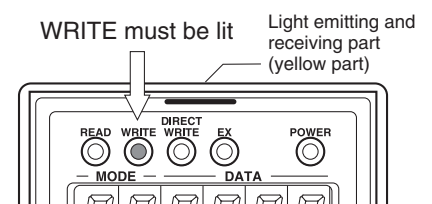

	How to operate	Display	Description	Set sound
1	Hold down the POWER button	048201	After the version is displayed	Beep, beep
		SELECT	SELEcT flashes	
2	Press the SELECT button	888888	Flashing	Beep
3	Press the SELECT button twice to turn on the DIRECT WRITE indicator (orange)	DIRECT WRITE (orange)	The DIRECT WRITE mode is selected	Beep
4	Press the SET button	Ad8880	The DIRECT WRITE mode is determined	Beep
5	Press the SET button	Ad.8880	Flashing dots move to the right	Beep
6	Press the L button three times	Ad.8880	Flashing dots move to the left	
7	Press the UP/DOWN button to show H	AdH880	H indicates word address	Beep
8	Press the R button three times	AdH880	Flashing dots move to the right	
9	Display the address number to be written by using the UP/DOWN button If the set value is 0, each time the R button is pressed, +50 is added. If the set value is not 0, it returns to 0 when the R button is pressed.	AdH8804 Ex.)	When setting to word address 4	
10	Point the light emitting and receiving part at the setting port of the target unit, and press the SET button	Ad8888	During the writing operation	Beep
11	In the case of success in writing	808888	After Good flashes	BEEP!
		AdH8804 Ex.)	The written value is displayed	
12	Address writing operation (Operation Nos. 6 and 7) for a different unit can be performed			Beep
13	In the case of failure in writing	Ad.8Err	Err display	Beep, beep, beep, beep, beep
14	Reset the light emitting and receiving part, and press the SET button again to repeat the writing operation (Operation No. 7)			
15	- Clear the Err display - Change to another mode Press the CLEAR button	AdH8804 Ex.)	Return to DIRECT WRITE mode display	Beep
16	Press the CLEAR button	Ad.8880	Flashing dots move to the left	Beep
17	When moving to the next setting, press the SELECT button to light up the display of the desired mode	READ (green) WRITE (yellow) DIRECT WRITE (orange) EX (red)		Beep



To write a word address from a word-compatible remote unit, an address writer of Ver. 2.01 or later version is required.
If you attempt to write a word address into a remote unit incompatible with word address setting, error code "E-0306" is displayed.

DIRECT WRITE must be lit
Light emitting and receiving part (yellow part)

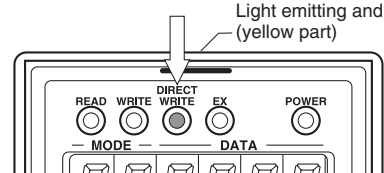

■ Parameter writing operation *Writing in the WRITE mode (example)

	How to operate	Display	Description	Set sound
1	Hold down the POWER button	043401	After the version is displayed	Beep, beep
		SELECT	SELECT flashes	
2	Press the SELECT button	□□□□□□	Flashing	Beep
3	Press the SELECT button several times to turn on the WRITE indicator (yellow)*	WRITE (yellow)	The WRITE mode is selected	Beep
4	Press the SET button	Ad.□□□□	The WRITE mode is determined	Beep
5	Select the parameter number to be written by using the UP/DOWN button	01.□□□□□ Ex.)	When selecting parameter 01	Beep
6	Press the SET button	01.□□□□□ Ex.)	Flashing dots move to the right	Beep
7	Select the parameter value to be written by using the UP/DOWN button	01.□□□□□ Ex.)	When setting the variable to "1" in parameter 01	Beep
8	Point the light emitting and receiving part at the setting port of the target unit, and press the SET button	01.□□□□□	During the writing operation	
9	In the case of success in writing	Good	After Good flashes	BEEP!
		01.□□□□□ Ex.)	The written value is displayed	
10	Parameter writing operation (Operation Nos. 7 and 8) for a different unit can be performed (If returning by the CLEAR button, the parameter number can be changed (Operation Nos. 5 and 6).)			
11	In the case of failure in writing	01.Err	Err display	Beep, beep, beep, beep, beep
12	Reset the light emitting and receiving part, and press the SET button again to repeat the writing operation (Operation No. 8)			
13	- Clear the Err display - Change to another mode Press the CLEAR button	01.□□□□□ Ex.)	Return to DIRECT WRITE mode display	Beep
14	Press the CLEAR button	01.□□□□□	Flashing dots move to the left	Beep
15	When moving to the next setting, press the SELECT button to light up the display of the desired mode	READ (green) WRITE (yellow) DIRECT WRITE (orange) EX (red)		Beep

CAUTION
If you attempt to write a parameter number that the remote unit does not support or a variable out of the setting range, "E-0303" is displayed.

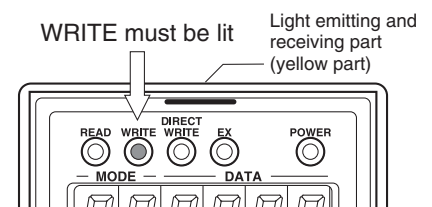

[Battery Replacement]

If the POWER indicator lamp flashes, the battery is almost dead. Please replace it with new one.

■ Battery replacement

	Condition	Display	Meaning
1	POWER button ON	POWER indicator lamp flashes <i>CHARGE</i>	Battery is almost dead
2	POWER button OFF		Battery replacement

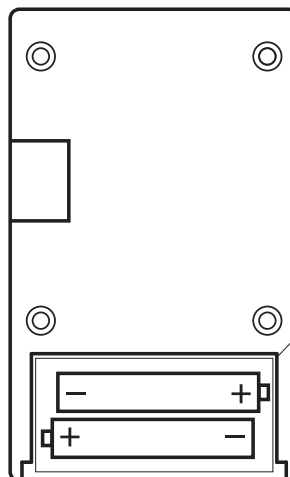
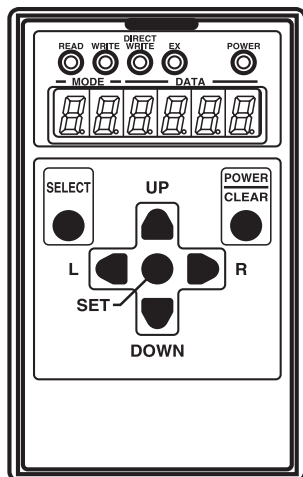

Battery case

2 AAA dry batteries

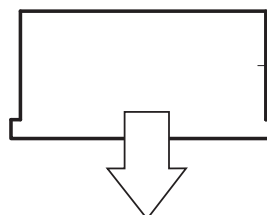

Battery case cover

Please pull the cover in the arrow direction.

for battery
EU



- Be sure to use AAA alkaline dry cell batteries.
- If not put in the correct directions, it may cause a failure, breakage, etc.
- Properly dispose of used batteries in accordance with the regulations of each local government.

[Specifications]

■ General specifications

Power supply	AAA alkaline dry cell battery: 2 pieces
Operating ambient temperature	0 to +55°C
Operating ambient humidity	10 to 90%RH No condensation
Storing temperature	-25 to +75°C
Atmosphere	No corrosive gas
Operating altitude*1	0 to 2000m
Pollution level*2	2 or less

*1 Do not use or store the product in an environment where the pressure exceeds the atmospheric pressure at an altitude of 0m. Doing so may result in malfunction.

*2 "Pollution level" is an index that indicates the degree of occurrence of conductive substances in the environment where the product is used.
Pollution level 2 means the occurrence of only pollution by non-conductive substances.
In such an environment, however, electrical conduction could occur due to accidental condensation.

■ Individual specifications

Weight	100g (Including batteries)
--------	----------------------------

■ Type of battery

type of applicable battery	AAA alkaline dry cell battery
----------------------------	-------------------------------

for battery
EU



Note: This symbol mark is prescribed in Article 13 "Labelling and marking of batteries" and Annex VI of EU Battery Regulation (EU 2023/1542).
Anywire products have been designed and manufactured by using high-quality materials and parts, in consideration of their recycling and reuse.
The above mark means that batteries and storage batteries must be separated from general refuse during disposal.
Also, when a symbol of element is shown under this mark, it means that the relevant batteries or storage batteries contain heavy metal at the standard or higher concentration.
The standard of concentration is as follows:

Hg: mercury (0.0005%), Cd: cadmium (0.002%), Pb: lead (0.004%)

For disposal of used batteries and storage batteries, separate collecting systems are established in EU.
Dispose of batteries and storage batteries properly at collecting/recycling facilities in each district.
We ask for your cooperation to protect our local environment.

[Outside Dimensions]

Unit: mm

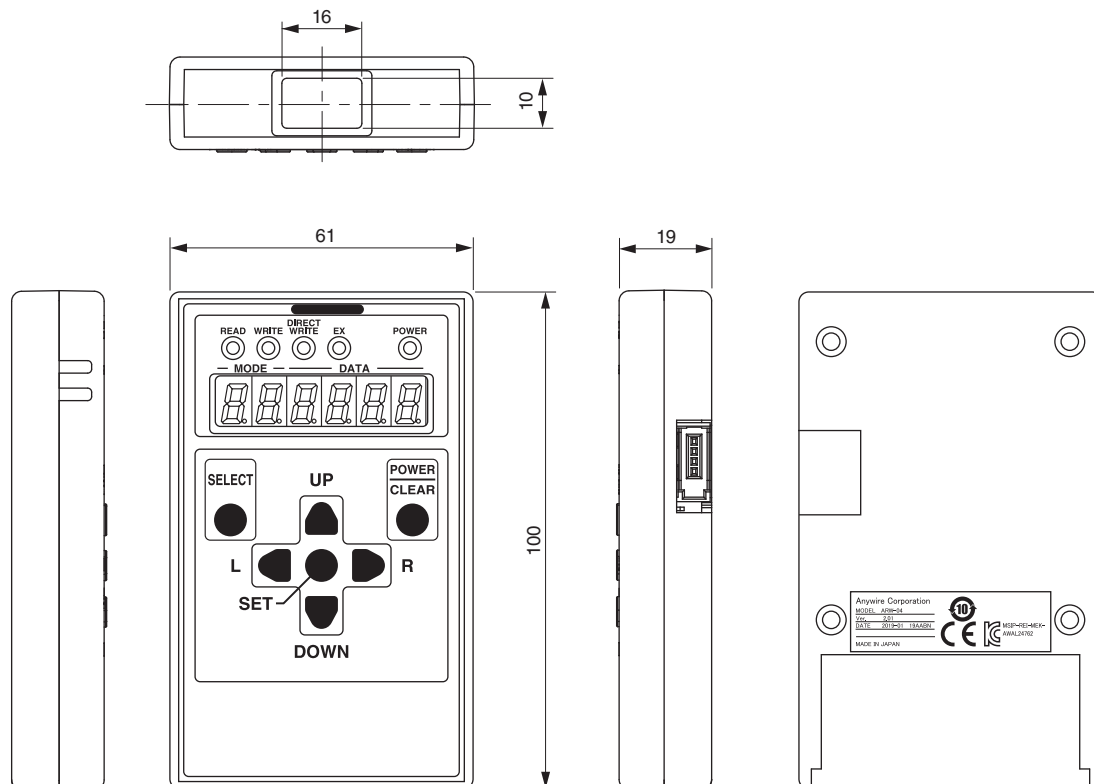

【中国版RoHS指令】

的产品中有害物质的名称及含量

部件名称	有害物质					
	铅 (Pb)	汞 (Hg)	镉 (Cd)	六价铬 [Cr (VI)]	多溴联苯 (PBB)	多溴二苯醚 (PBDE)
安装基板	×	○	○	○	○	○
框架	○	○	○	○	○	○

本表格依据 SJ/T11364 的规定编制。
○：表示该有害物质在该部件所有均质材料中的含量均在 GB/T26572 规定的限量要求以下。
×：表示该有害物质至少在该部件的某一均质材料中的含量超出 GB/T26572 规定的限量要求。



基于中国标准法的参考规格：GB/T15969.2

[Address]

Anywire Anywire Corporation

Headquarters :1 Babazusho, Nagaokakyo-shi, Kyoto 617-8550 JAPAN

Contact :Contact by mail info_e@anywire.jp
:Contact by website http://www.anywire.jp